

EDK82EV903  
13216483

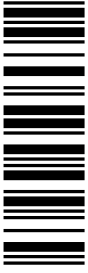

Information for the operator of the machine

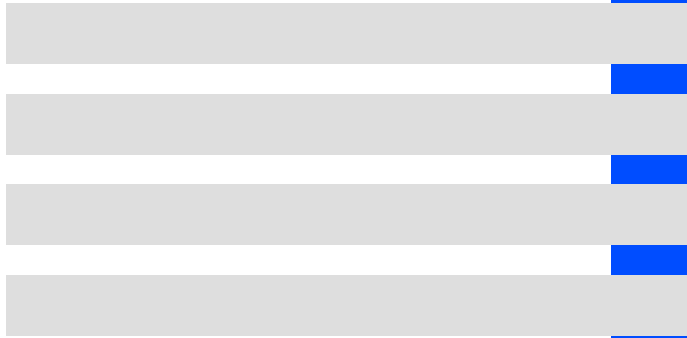

## 8200 vector 45 ... 90 kW

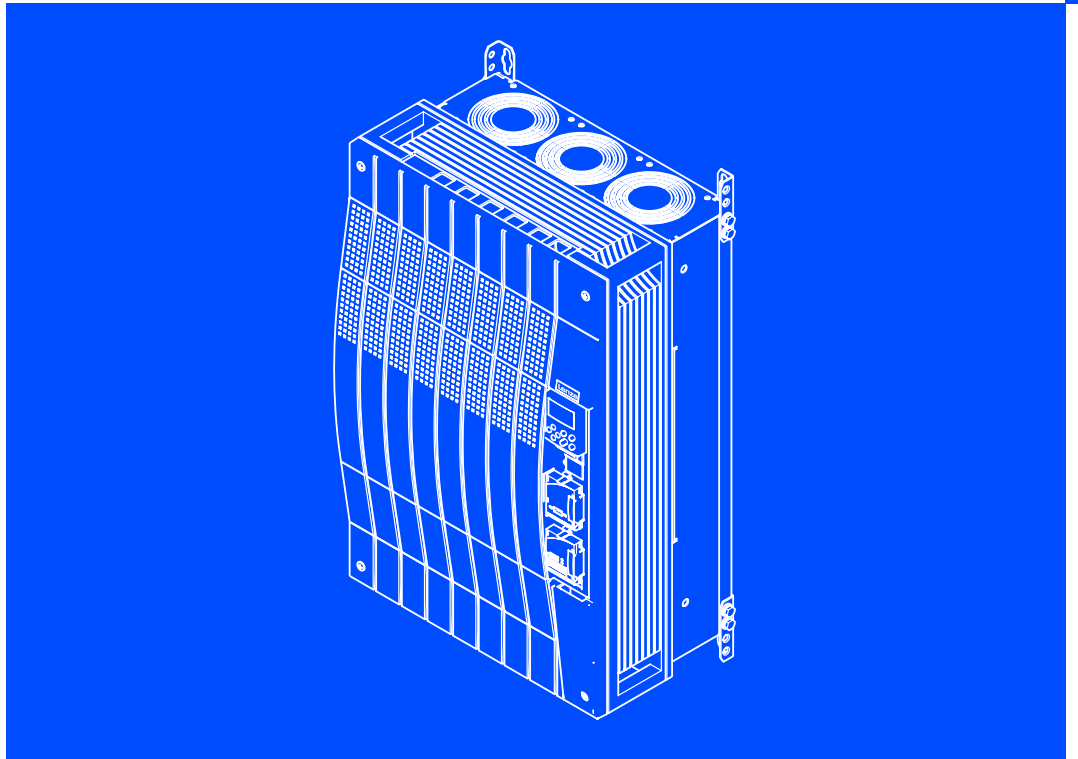

E82xV453Kxxxxx... E82xV903Kxxxxx

Frequency inverter

**Lenze**

# This documentation is valid for ...

... 8200 vector frequency inverters as of nameplate data:

	①	②	③	Nameplate							
	E82	x	V	xxx	K	4	B	xxx	3x	3x	
<b>Product series</b>	8200 vector										
<b>Type</b>	E = Panel-mounted unit C = Built-in unit in "cold plate" technique D = Built-in unit in "push-through" technique										
<b>Design</b>	V = Vector-controlled frequency inverter										
<b>Rated power [W]</b>	453 = $45 \times 10^3$ W = 45 kW 553 = $55 \times 10^3$ W = 55 kW 753 = $75 \times 10^3$ W = 75 kW 903 = $90 \times 10^3$ W = 90 kW										
<b>Voltage class</b>	4 = 400 V / 500 V										
<b>Version</b>											
<b>Variant</b>	0xx = EMC filter integrated 1xx = For IT systems 2xx = Without EMC filter x0x = Without "safe standstill" function x4x = With "safe standstill" function xx0 = Not coated xx1 = Coated										
<b>Hardware version</b>											
<b>Software version</b>											

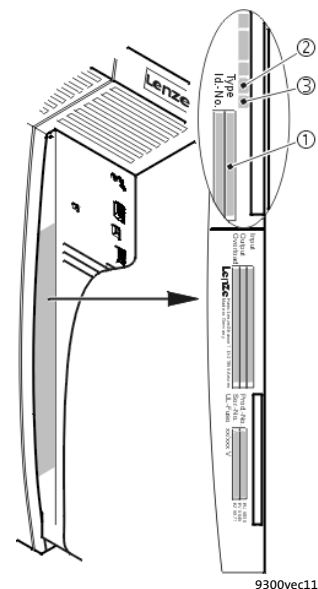



### **Note!**

**This documentation contains all the information required by the machine operator to run the drive controllers of the 8200 vector series installed in your machine/system.**

**You may make further use of the information contained in this documentation without asking Lenze for permission if you do not change the contents.**



### **Tip!**

Current documentation and software updates concerning Lenze products can be found on the Internet in the "Services & Downloads" area under

**<http://www.Lenze.com>**

**E82EV453Kxxxxx, E82EV553Kxxxxx**

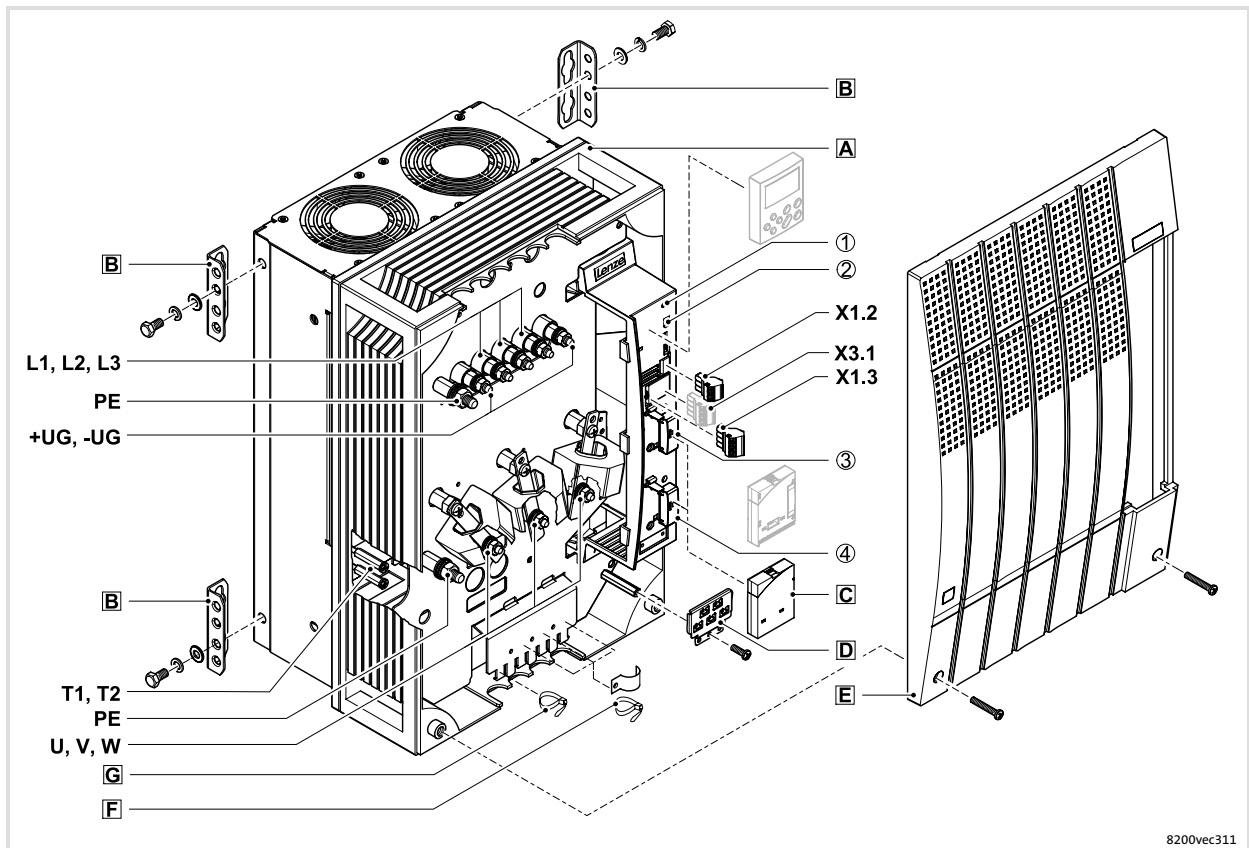

8200vec311

**E82EV753Kxxxxx, E82EV903Kxxxxx**

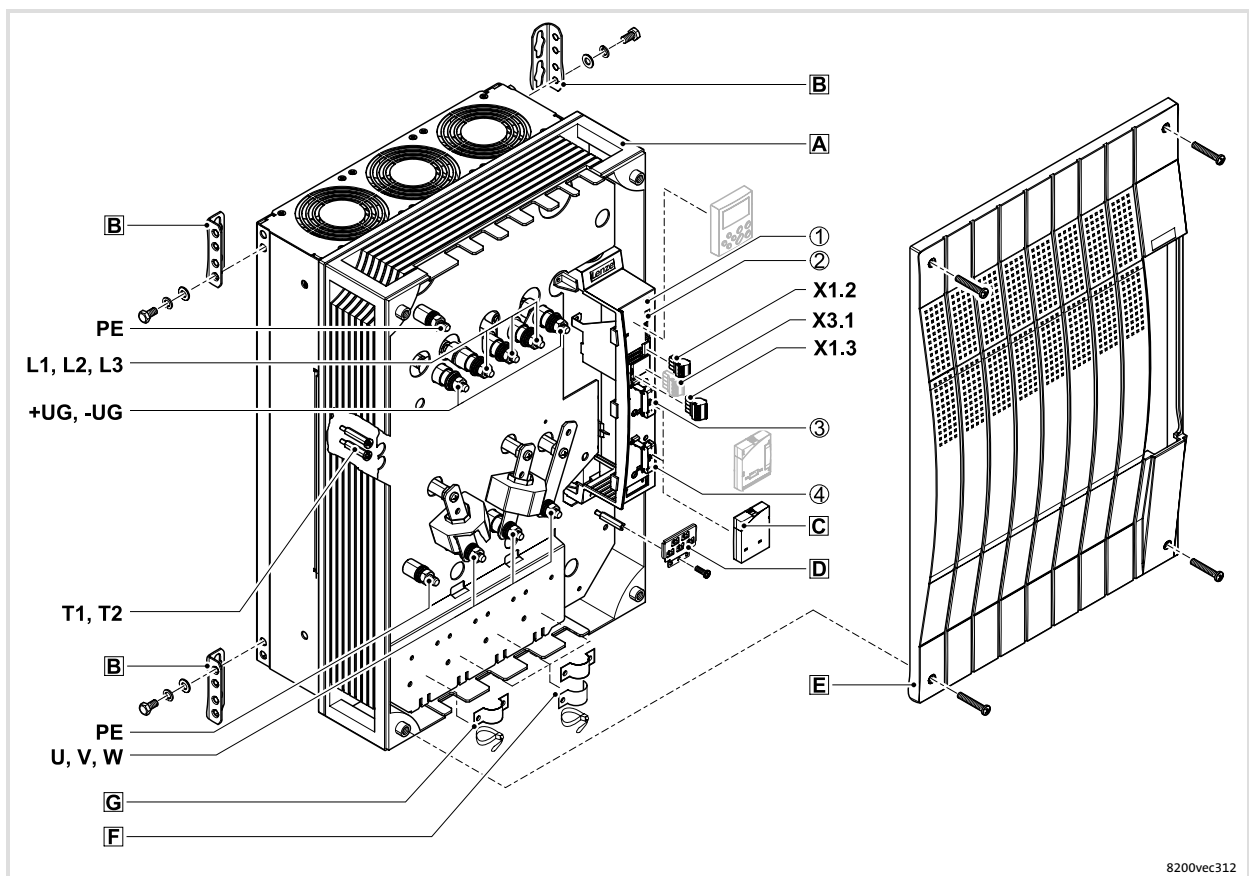

8200vec312

## Key for overview

Position	Description
A	Frequency inverter
B	Fixing bracket for standard mounting
C	Blind covers (2 items) for the FIF I and FIF II interfaces
D	EMC shield sheet with fixing screws for shielded control cables
E	Cover with fixing screws
F	Shield clamp and strain relief for the motor cable
G	Strain relief for the protective earth cable of the motor and the incoming cable of the motor temperature monitoring with PTC thermistor (PTC) or thermal contact (NC contact)
T1, T2	Connection for PTC or thermal contact (NC contact) of the motor
U, V, W, PE	Motor connection
L1, L2, L3, PE +U <sub>G</sub> , -U <sub>G</sub>	Mains connection, DC supply
X1.2	Terminal strip for connection of relay output K1
X1.3	Terminal strip for connection of relay output K2
X3.1	Terminal strip for connection of relay output K <sub>SR</sub> for "safe standstill" (for Bx4x variant only)

## Interfaces and displays

Position	Description	Function
①	2 light-emitting diodes (red, green)	Status display
②	AIF interface (automation interface)	Slot for communication module e. g. E82ZBC keypad
③	FIF I interface (function interface)	With cover for operation without function module or slot for function module
④	FIF II interface (function interface)	With cover for operation without function module or slot for function module

<b>1</b>	<b>Safety instructions</b> .....	<b>7</b>
1.1	General safety and application notes for Lenze controllers .....	7
1.2	Residual hazards .....	9
1.3	Definition of notes used .....	11
<b>2</b>	<b>Parameter setting</b> .....	<b>12</b>
2.1	Parameter setting with E82ZBC keypad .....	12
2.1.1	Installation and commissioning .....	12
2.1.2	Display elements and function keys .....	13
2.1.3	Changing and saving parameters .....	15
2.1.4	Menu structure .....	16
<b>3</b>	<b>Troubleshooting and fault elimination</b> .....	<b>18</b>
3.1	Malfunction of the drive .....	18
3.2	Troubleshooting .....	19
3.3	Fault messages on the keypad or in the parameter setting program Global Drive Control .....	20

# 1 Safety instructions

## 1.1 General safety and application notes for Lenze controllers

(in accordance with Low-Voltage Directive 2006/95/EC)

### For your personal safety

Lenze controllers (frequency inverters, servo inverters, DC speed controllers) and the accessory components can include live and rotating parts - depending on their type of protection - during operation. Surfaces can be hot.

Non-authorized removal of the required cover, inappropriate use, incorrect installation or operation, create the risk of severe injury to persons or damage to material assets.

More information can be obtained from the documentation.

Within the controller there are high energies. Therefore always wear personal protective equipment when working on the live controller (body protection, headgear, eye protection, ear protection, hand guard).

All operations concerning transport, installation, and commissioning as well as maintenance must be carried out by qualified, skilled personnel (IEC 364 and CENELEC HD 384 or DIN VDE 0100 and IEC report 664 or DIN VDE 0110 and national regulations for the prevention of accidents must be observed).

According to this basic safety information, qualified, skilled personnel are persons who are familiar with the assembly, installation, commissioning, and operation of the product and who have the qualifications necessary for their occupation.

### Application as directed

Drive controllers are components which are designed for the installation into electrical systems or machinery. They are not to be used as domestic appliances, but as components only for industrial or professional purposes according to EN 61000-3-2.

When installing the controllers into machines, commissioning (i.e. starting of operation as directed) is prohibited until it is proven that the machine complies with the regulations of the EC Directive 98/37/EC (Machinery Directive); EN 60204 must be observed.

Commissioning (i.e. starting of operation as directed) is only allowed when there is compliance with the EMC Directive (89/336/EEC).

The controllers meet the requirements of the Low-Voltage Directive 73/23/EEC. The harmonised standard EN 61800-5-1 applies to the controllers.

The technical data and information on connection conditions must be obtained from the nameplate and the documentation. They must be observed in any case.

**Warning:** Drive controllers are products that can be used in drive systems of category 2 according to EN 61800-3. These products can cause radio interferences in residential areas. In this case, special measures are required.

### Transport, storage

Please observe the notes on transport, storage and appropriate handling.

Observe the climatic conditions according to the technical data.

## Installation

The controllers must be installed and cooled according to the instructions given in the corresponding documentation.

Ensure proper handling and avoid mechanical stress. Do not bend any components and do not change any insulation distances during transport or handling. Do not touch any electronic components and contacts.

Controllers contain electrostatically sensitive components, which can easily be damaged by inappropriate handling. Do not damage or destroy any electrical components since this might endanger your health!

## Electrical connection

When working on live controllers, the valid national regulations for the prevention of accidents (e.g. VBG 4) must be observed.

The electrical installation must be carried out according to the appropriate regulations (e.g. cable cross-sections, fuses, PE connection). Additional information can be obtained from the documentation.

The documentation contains notes for the EMC-compliant installation (shielding, earthing, arrangement of filters, and cable routing). Also observe these notes for CE-labelled controllers. The manufacturer of the system or machine is responsible for the compliance with the limit values required in connection with EMC legislation. In order to comply with the limit values for radio interference applicable at the site of installation, you have to fit the controllers into housings (e. g. control cabinets). The housings have to provide for an EMC-compatible assembly. In particular, observe that for instance doors of control cabinets preferably are metalically connected to the housing in a circumferential manner. Reduce apertures or cutouts through the housing to a minimum.

Lenze controllers can cause a DC current within the PE conductor. If a residual current device (RCD) is used for protection in the cases of direct or indirect contact, only a residual current device (RCB) of the type B may be used on the supply side of the controller. Otherwise a different protective measure has to be used, e. g. separation from the environment by double or reinforced insulation, or disconnection from the supply system by using a transformer.

## Operation

If necessary, systems including controllers must be equipped with additional monitoring and protection devices according to the valid safety regulations (e.g. law on technical equipment, regulations for the prevention of accidents). The controller can be adapted to your application. Please observe the corresponding information given in the documentation.

After a controller has been disconnected from the voltage supply, all live components and power connections must not be touched immediately because capacitors can still be charged. Please observe the corresponding stickers on the controller.

All protection covers and doors must be shut during operation.

**Note for UL approved systems with integrated controllers:** UL warnings are notes that only apply to UL systems. The documentation contains special information about UL.

## Safety functions

Some variants of the controllers support safety functions (e. g. "safe torque off", formerly "safe standstill") according to the requirements of Appendix I no. 1.2.7 of the EC Directive "Machinery" 98/37/EC, EN 954-1 category 3 and EN 1037. The notes on the safety functions in the documentation of the variants must be strictly observed.



### **Maintenance and servicing**

The controllers do not require any maintenance, if the prescribed conditions of operation are observed.

If the ambient air is polluted, the cooling surfaces of the controller may become dirty or the air vents of the controller may be obstructed. Therefore, clean the cooling surfaces and air vents periodically under these operating conditions. Do not use sharp or pointed tools for this purpose!

### **Disposal**

Recycle metal and plastic materials. Ensure professional disposal of assembled PCBs.

**The product-specific safety and application notes given in these instructions must be observed!**

## **1.2**

### **Residual hazards**

#### **Protection of persons**

- ▶ Before working on the drive controller, check whether all power terminals, the relay output, and the pins of the FIF interfaces are deenergised, because
  - the power terminals U, V, W, +U<sub>G</sub>, -U<sub>G</sub> still carry dangerous voltage for at least 3 minutes after power-off.
  - the power terminals L1, L2, L3, U, V, W, +U<sub>G</sub>, -U<sub>G</sub> carry dangerous voltage when the motor is stopped.
  - the relay outputs K11, K12, K14 and K21, K22, K24 can carry dangerous voltage if the drive controller is disconnected from the mains.
- ▶ If you use the “selection of direction of rotation” via function which is not fail-safe against open circuit via the digital signal DCTRL1-CW/CCW (C0007 = 0 ... 13, C0410/3 ≠ 255):
  - In case of open circuit or failure of the control voltage, the drive may change the direction of rotation.
- ▶ If you use the “flying restart circuit” function (C0142 = 2, 3) for machines with a low moment of inertia and low friction:
  - After controller enable in standstill, the motor may start for a short period of time, or may temporarily change the direction of rotation.
- ▶ The operating temperature of the heatsink on the drive controller is > 80 °C:
  - Skin contact with the heatsink causes burns.
- ▶ Drive controllers with the “safe standstill” function:
  - In case of short circuit of two power transistors, a residual movement of up to 180°/number of pole pairs may result on the motor.
  - With regard to a 4-pole motor, for instance, the residual movement can be maximal 180°/2 = 90°. When effecting the hazard analysis, the user has to take this residual movement into account (e. g. safe standstill for main spindle drives).

**Device protection**

- ▶ All pluggable terminals can only be plugged in or unplugged when the controller is disconnected from the power supply!
- ▶ Frequent mains switching (e.g. inching mode via mains contactor) can overload and destroy the input current limitation of the controller:
  - Therefore at least 3 minutes must pass between two switch-on operations.

**Motor protection**

- ▶ Certain drive controller settings can overheat the connected motor:
  - E. g. long-time operation of the DC injection brake.
  - Long-time operation of self-ventilated motors at low speeds.

**Protection of the machine/system**

- ▶ Drives can reach dangerous overspeeds (e. g. setting of high output frequencies in connection with motors and machines not suitable for this purpose):
  - The drive controllers do not provide protection against such operating conditions. For this purpose, use additional components.

**Warnings!**

- ▶ The device has no overspeed protection.
- ▶ Must be provided with external or remote overload protection.
- ▶ Suitable for use on a circuit capable of delivering not more than 5000 rms symmetrical amperes, 240 V maximum (240 V devices) or 500 V maximum (400/500 V devices) resp.
- ▶ Use 60/75 °C or 75 °C copper wire only.
- ▶ Shall be installed in a pollution degree 2 macro-environment.

### 1.3 Definition of notes used

The following pictographs and signal words are used in this documentation to indicate dangers and important information:

#### Safety instructions

Structure of safety instructions:





#### **Danger!**



(characterises the type and severity of danger)

#### **Note**

(describes the danger and gives information about how to prevent dangerous situations)

Pictograph and signal word	Meaning
 <b>Danger!</b>	<b>Danger of personal injury through dangerous electrical voltage.</b> Reference to an imminent danger that may result in death or serious personal injury if the corresponding measures are not taken.
 <b>Danger!</b>	<b>Danger of personal injury through a general source of danger.</b> Reference to an imminent danger that may result in death or serious personal injury if the corresponding measures are not taken.
 <b>Stop!</b>	<b>Danger of property damage.</b> Reference to a possible danger that may result in property damage if the corresponding measures are not taken.

#### Application notes

Pictograph and signal word	Meaning
 <b>Note!</b>	Important note to ensure troublefree operation
 <b>Tip!</b>	Useful tip for simple handling
	Reference to another documentation

## 2 Parameter setting

### Parameter setting with E82ZBC keypad Installation and commissioning

## 2 Parameter setting

### 2.1 Parameter setting with E82ZBC keypad

#### Description

The keypad is available as an accessory. A full description of the keypad can be obtained from the Instructions included in the keypad delivery.

#### Plugging in the keypad

It is possible to plug the keypad into the AIF interface or remove it during operation.

As soon as the keypad is supplied with voltage, it carries out a self-test. The keypad is ready for operation if it is in display mode.

#### 2.1.1 Installation and commissioning

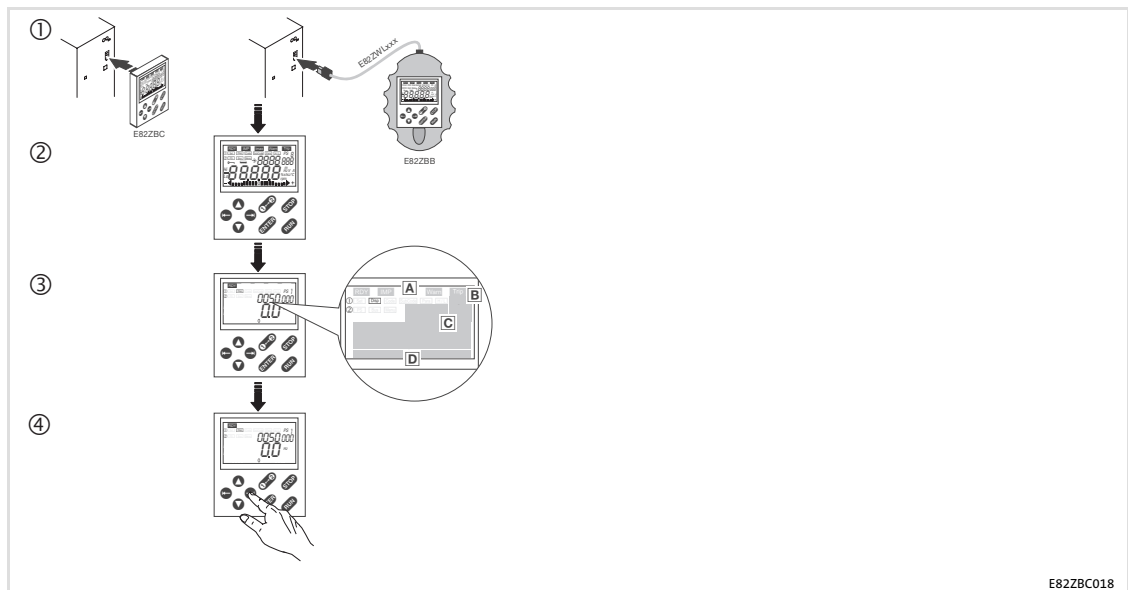

- ① Connect keypad to the AIF interface on the front of the standard device.  
It is possible to connect the keypad and remove it during operation.
- ② As soon as the keypad is supplied with voltage, it carries out a short self-test.
- ③ The keypad is ready for operation, if it displays the "Disp" mode:
  - A Current state of the standard device
  - B Parameter set activated via terminal
  - C Memory location 1 of the user menu (C0517):  
Code number, subcode number, and current value
  - D Current value in % of the status display defined in C0004
- ④ Press **Disp** to leave the "Disp" mode

2.1.2 Display elements and function keys

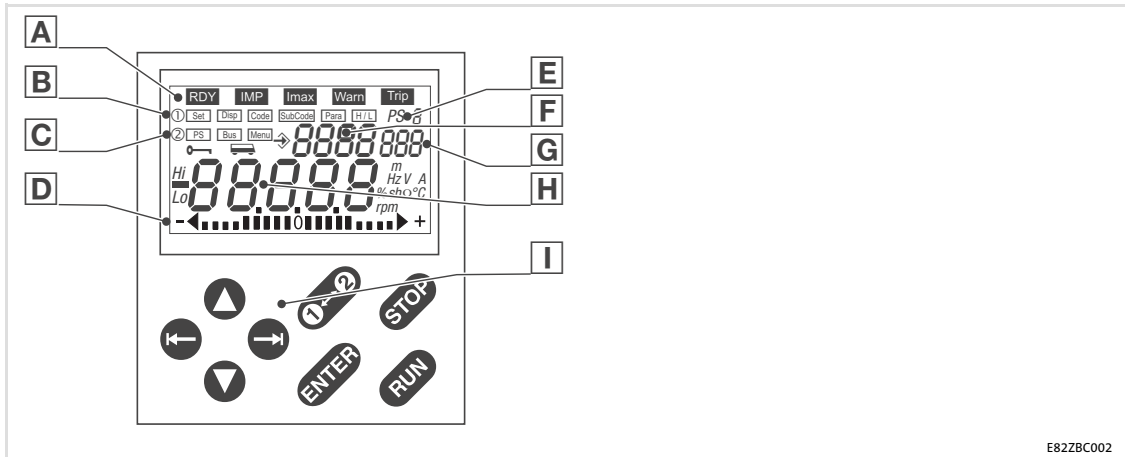

E82ZBC002

Displays







Display	Meaning	Explanation
<b>A</b>	<b>Status displays</b>	
<b>RDY</b>	Ready for operation	
<b>IMP</b>	Pulse inhibit active	Power outputs are inhibited
<b>Imax</b>	Set current limit exceeded in motor or generator mode	C0022 (in motor mode) or C0023 (in generator mode)
<b>Warn</b>	Warning active	
<b>Trip</b>	Fault active	
<b>B</b>	<b>Function bar 1</b>	
<b>Set</b>	Setpoint selection via	Not possible if password protection is active (display = "LOC")
<b>Disp</b>	Display function: • Display user menu, memory location 1 (C0517/1) • Display active parameter set	Active after every mains connection
<b>Code</b>	Select codes	Four-digit display of the active code <b>F</b>
<b>SubCode</b>	Select subcodes	Three-digit display of the active subcode <b>G</b>
<b>Para</b>	Change parameter value of a code/subcode	Five-digit display of the actual value <b>H</b>
<b>HTL</b>	Display values which have more than 5 digits	
	H: higher-order digits	Display of "Hi"
	L: lower-order digits	Display of "Lo"
<b>C</b>	<b>Function bar 2</b>	
<b>PS</b>	Select parameter set 1 ... 4 for changing	<ul style="list-style-type: none"> <li>• Display of e.g. PS 2 (<b>E</b>)</li> <li>• The parameter sets can only be activated via digital signals (configuration with C0410)</li> </ul>
<b>Bus</b>	Select node of the system bus (CAN)	The selected node can be parameterised from the current drive = Function is active
<b>Menu</b>	Select menu <b>The user menu is active after every mains switching</b>	<i>user</i> List of the codes in the user menu (C0517) <i>ALL</i> List of all codes <i>FuncI</i> Only specific codes for bus function modules, e.g. INTERBUS, PROFIBUS-DP, LECOM-B, ...

## Parameter setting

Parameter setting with E82ZBC keypad  
Display elements and function keys

Display	Meaning	Explanation
<b>D</b>	<b>Bar graph display</b>	
	Value set in C0004 in % (Lenze setting: Device utilisation C0056)	Display range: - 180 % ... + 180 % (1 mark = 20 %)
<b>E</b>	<b>Parameter set display</b>	
	In the <b>[Disp]</b> mode: Display of the parameter set activated via digital signal	
	Otherwise: Display of the parameter set active for changing	Select the individual parameter sets in the <b>[PS]</b> mode in the function bar 2
<b>F</b>	<b>Code number display</b>	
<b>G</b>	<b>Subcode number display</b>	
<b>H</b>	<b>Display of parameter value or fault message</b>	

### Function keys

Pos.	Key	Function	Explanation
<b>I</b>	<b>Function keys</b>		
		Enable controller	For operation with a function module, the X3/28 terminal must be set to HIGH level.
		Inhibit controller (CINH) or quick stop (QSP)	Configuration in C0469; inactive if the standard device is running in manual mode (C0410/17)
		Change between function bar 1 ↔ function bar 2	
		To the right/left in the active function bar	The active function is framed.
		Increase/decrease value Quick change: Keep the key pressed	Only blinking values can be changed.
		Store parameters if  is blinking Confirmation by <i>STO-r-E</i> in the display	

## 2.1.3 Changing and saving parameters



### Note!

- ▶ The *USER* menu is active after mains switching. Change to the *ALL* menu to address all codes.
- ▶ With the keypad you can only change parameter values in the parameter sets.
- ▶ A parameter set can only be activated for operation by means of digital signals (configuration via C0410)!
- ▶ In the Disp function, the keypad shows the parameter set which is currently active during operation.

Step		Key sequence	Result	Action
1.	Connect keypad		<span style="border: 1px solid black; padding: 0 2px;">Disp</span> XX.XX Hz	The <span style="border: 1px solid black; padding: 0 2px;">Disp</span> function is active. The first code in the user menu is displayed (C0517/1, Lenze setting: C0050 = output frequency).
2.	If required, change to the "ALL" menu		2	Change to function bar 2
3.			<span style="border: 1px solid black; padding: 0 2px;">Menu</span>	
4.			ALL	Select "ALL" menu (list of all codes)
5.			1	Confirm selection and change to function bar 1
6.	Select parameter set for change		2	Change to function bar 2
7.			<span style="border: 1px solid black; padding: 0 2px;">PS</span>	
8.			1 ... 4	Select parameter set to be changed
9.			1	Confirm selection and change to function bar 1
10.	Inhibit controller		<span style="border: 1px solid black; padding: 0 2px;">RDY</span> <span style="border: 1px solid black; padding: 0 2px;">IMP</span>	Only necessary if you change C0002, C0148, C0174, and/or C0469
11.	Set parameters		<span style="border: 1px solid black; padding: 0 2px;">Code</span>	
12.			XXXX	Select code
13.			<span style="border: 1px solid black; padding: 0 2px;">SubCode</span> 00i	For codes without subcodes: automatic skip to <span style="border: 1px solid black; padding: 0 2px;">Para</span>
14.			XXX	Select subcode
15.			<span style="border: 1px solid black; padding: 0 2px;">Para</span>	
16.			XXXXX	Set parameter
17.			STO-E	Confirm entry if  is blinking
				Confirm entry if  is not blinking; <span style="border: 1px solid black; padding: 0 2px;">ENTER</span> is inactive
18.				Restart "loop" at 11. or 6. to set further parameters

**2.1.4 Menu structure**

For easy operation, the codes are grouped into two menus:

- ▶ The *uSEr* menu
  - is active after every mains switching or after connection of the keypad during operation.
  - contains all codes for a standard application with linear V/f characteristic control (Lenze setting).
  - can be modified as required under C0517.
- ▶ The *ALL* menu
  - contains all codes.
  - shows a list of all codes in numerically ascending order.

**The *uSEr* menu - the 10 most important drive parameters at a glance**

After every mains switching, or after connection of the keypad during operation, the 10 codes that have been defined in code C0517 are immediately available.

In the Lenze setting, the *uSEr* menu contains all codes required for starting up a standard application with linear V/f characteristic control:



Code	Designation	Lenze setting				
C0050	Output frequency		Display: output frequency without slip compensation			
C0034	Setpoint selection range	0	Standard I/O X3/8: 0 ... 5 V / 0 ... 10 V / 0 ... 20 mA			
			Application I/O X3/1U: 0 ... 5 V / 0 ... 10 V X3/2U: 0 ... 5 V / 0 ... 10 V			
C0007	Fixed configuration of digital inputs	0	E4	E3	E2	E1
			CW/CCW	DCB	JOG2/3	JOG1/3
			CW/CCW rotation	DC injection brake	Selection of fixed setpoints	
C0010	Minimum output frequency	0.00 Hz				
C0011	Maximum output frequency	50.00 Hz				
C0012	Acceleration time of main setpoint	5.00 s				
C0013	Deceleration time main of setpoint	5.00 s				
C0015	V/f rated frequency	50.00 Hz				
C0016	V <sub>min</sub> boost	Device-dependent				
C0002	Parameter set management		Re-establish delivery status; transfer parameter sets with the keypad; save, load, or copy own basic settings			



### Note!

Via C0002 "parameter set transfer/re-establishing of delivery status", you can transfer configurations from one drive controller to another by means of the keypad, or re-establish the delivery status by loading the Lenze setting (e. g. if you've lost track during parameterising).

### Change between the menus *USER* and *ALL*

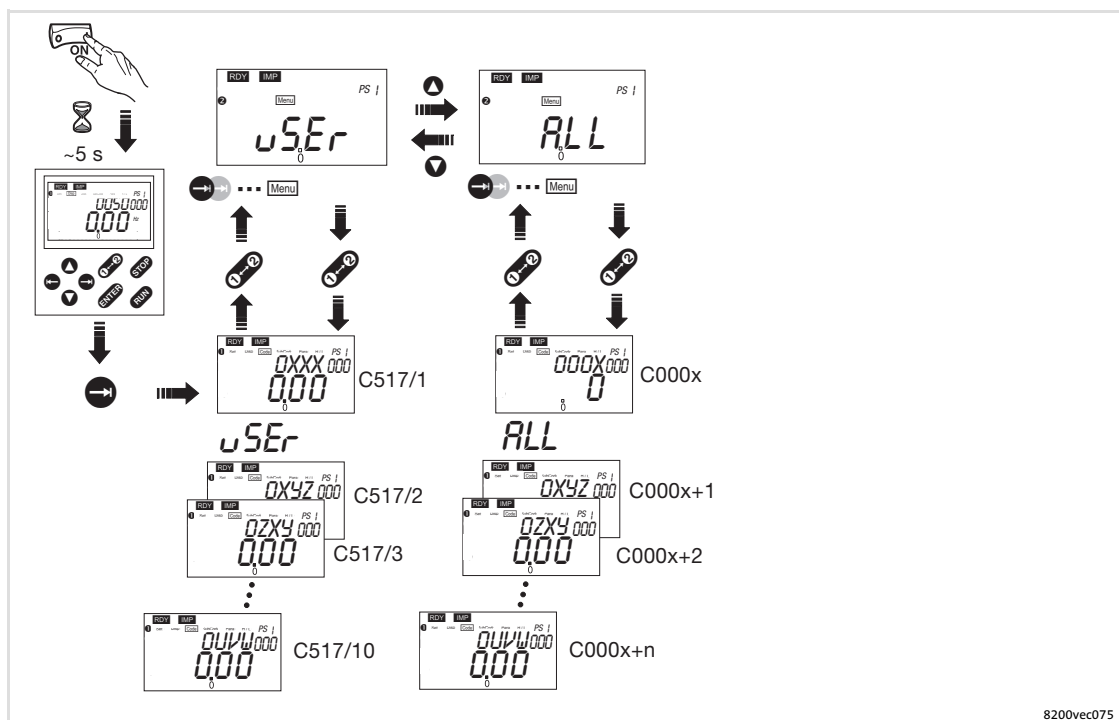

8200vec075

### 3 Troubleshooting and fault elimination

#### Malfunction of the drive

### 3 Troubleshooting and fault elimination

#### 3.1 Malfunction of the drive

Malfunction	Cause	Remedy
<b>Motor does not rotate</b>	DC-bus voltage too low (red LED is blinking every 0.4 s; keypad displays: <i>LL</i> )	Check mains voltage
	Controller inhibited (green LED is blinking, keypad displays: <i>IMP</i> )	Deactivate controller inhibit, controller inhibit can be set via several sources
	Automatic start inhibited (C0142 = 0 or 2)	LOW-HIGH edge at X3/28 If necessary, correct starting condition (C0142)
	DC-injection braking (DCB) active	Deactivate DC injection brake
	Mechanical motor brake is not released	Manual or electrical release of mechanical motor brake
	Quick stop (QSP) active (keypad displays: <i>IMP</i> )	Deactivate quick stop
	Setpoint = 0	Select setpoint
	JOG setpoint activated and JOG frequency = 0	Select JOG setpoint (C0037 ... C0039)
	Active fault	Eliminate fault
	Incorrect parameter set active	Change to correct parameter set via terminal
	Operating mode C0014 = -4-, -5- set, but no motor parameter identification	Identify motor parameters (C0148)
	Assignment of several functions excluding each other to one signal source in C0410	Correct configuration in C0410
	Use of internal voltage source X3/20 for the function modules Standard I/O, INTERBUS, PROFIBUS-DP, or LECOM-B (RS485): No jumper between X3/7 and X3/39	Jumper terminals
<b>Motor does not rotate smoothly</b>	Motor cable defective	Check motor cable
	Maximum current set too low (C0022, C0023)	Adjust settings to the application
	Motor is under- or overexcited	Check parameter setting (C0015, C0016, C0014)
	C0084, C0087, C0088, C0089, C0090, C0091 and/or C0092 not adjusted to the motor data	Adjust codes manually or identify motor parameters (C0148); optimise vector control
<b>Current consumption of motor too high</b>	Setting of C0016 too high	Correct setting
	Setting of C0015 too low	Correct setting
	C0084, C0087, C0088, C0089, C0090, C0091 and/or C0092 not adjusted to the motor data	Adjust codes manually or identify motor parameters (C0148); optimise vector control
<b>Motor rotates, setpoints are "0"</b>	With the  function of the keypad a setpoint has been selected	Set setpoint to "0" with C0140 = 0
<b>Motor parameter identification stops with error LP1</b>	Motor is too small in relation to the rated power of the drive	
	DC injection brake (DCB) active via terminal	
<b>Unacceptable drive response with vector control</b>	Various	Optimise vector control
<b>Torque dip in the field weakening range</b>	Various	Contact Lenze
<b>Stalling of the motor when operating in the field weakening range</b>		

### 3.2 Troubleshooting

LED red ①	LED green ②	Operating status
Off	On	Drive controller enabled
On	On	Mains switched on and automatic start inhibited
Off	Blinking slowly	Drive controller inhibited
Off	Blinking quickly	Motor parameter identification
Blinking quickly	Off	Undervoltage or overvoltage
Blinking slowly	Off	Fault active, check in C0161

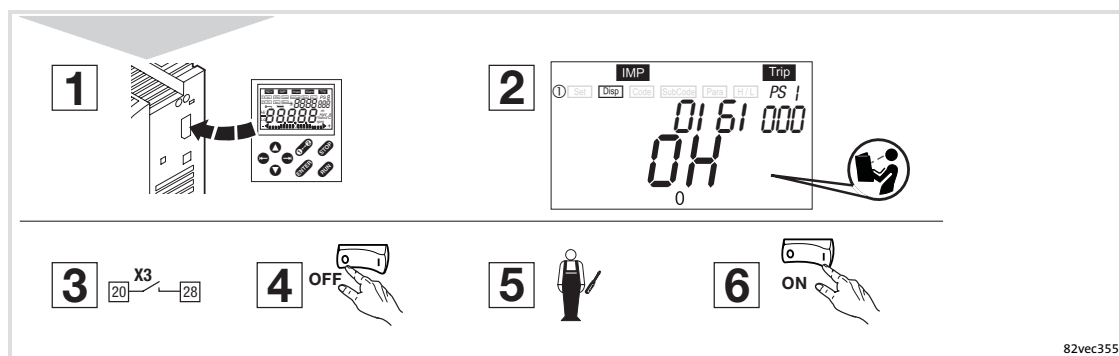
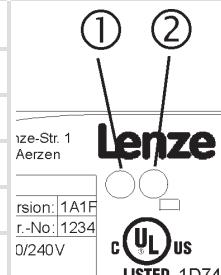

Reset the drive controller in this way if a fault occurs (TRIP reset):

1. Plug the keypad onto the AIF interface during operation.
2. Read and take down fault message on the keypad display.
3. Inhibit controller.
4. Disconnect controller from the mains.
5. Carry out a fault analysis and eliminate the faults.
6. Restart the controller.

#### 3.3 Fault messages on the keypad or in the parameter setting program Global Drive Control

Keypad	PC 1)	Fault	Cause	Remedy
nDEr	0	No fault	-	-
CCr Trip	71	System failure	Strong interference injections on the control cables Earth loops in the wiring	Shield control cable
CE0 Trip	61	Communication error on AIF (configurable in C0126)	Faulty transmission of control commands via AIF	Insert the communication module properly into the diagnosis terminal
CE1 Trip	62	Communication error on CAN-IN1 with sync control	CAN-IN1 object receives faulty data or communication is interrupted	<ul style="list-style-type: none"> <li>Check plug connection of bus module ↔ FIF</li> <li>Check sender</li> <li>Increase monitoring time in C0357/1, if necessary</li> </ul>
CE2 Trip	63	Communication error on CAN-IN2	CAN-IN2 object receives faulty data or communication is interrupted	<ul style="list-style-type: none"> <li>Check plug connection of bus module ↔ FIF</li> <li>Check sender</li> <li>Increase monitoring time in C0357/2, if necessary</li> </ul>
CE3 Trip	64	Communication error on CAN-IN1 with event or time control	CAN-IN1 object receives faulty data or communication is interrupted	<ul style="list-style-type: none"> <li>Check plug connection of bus module ↔ FIF</li> <li>Check sender</li> <li>Increase monitoring time in C0357/3, if necessary</li> </ul>
CE4 Trip	65	BUS-OFF (many communication errors occurred)	Controller has received too many faulty telegrams via the system bus and has been disconnected from the bus	<ul style="list-style-type: none"> <li>Check whether bus termination is available</li> <li>Check shield connection of the cables</li> <li>Check PE connection</li> <li>Check bus load, reduce the baud rate, if necessary</li> </ul>
CE5 Trip	66	CAN time-out (configurable in C0126)	In case of remote parameterisation via the system bus (C0370): Slave does not respond. Communication monitoring time has been exceeded  When operating with Application I/O: Parameter set change-over has been parameterised incorrectly  When operating with module on FIF: Internal error	<ul style="list-style-type: none"> <li>Check wiring of the system bus</li> <li>Check system bus configuration</li> </ul> In all parameter sets, the "change parameter set" signal (C0410/13, C0410/14) must be connected with the same source  Contact Lenze
CE6 Trip	67	System bus (CAN) function module on FIF has the "Warning" or "BUS-OFF" status (configurable in C0126)	CAN controller signals "Warning" or "BUS-OFF" status	<ul style="list-style-type: none"> <li>Check whether bus termination is available</li> <li>Check shield connection of the cables</li> <li>Check PE connection</li> <li>Check bus load, reduce the baud rate, if necessary</li> </ul>
CE7 Trip	68	Communication error in case of remote parameterisation via the system bus (C0370) (configurable in C0126)	Node does not respond or is not available  When operating with Application I/O: Parameter set change-over has been parameterised incorrectly	<ul style="list-style-type: none"> <li>Check whether bus termination is available</li> <li>Check shield connection of the cables</li> <li>Check PE connection</li> <li>Check bus load, reduce the baud rate, if necessary</li> </ul> In all parameter sets, the "change parameter set" signal (C0410/13, C0410/14) must be connected with the same source
EEr Trip	91	External fault (TRIP-SET)	A digital signal assigned to the TRIP-SET function is activated	Check external encoder

Keypad	PC 1)	Fault	Cause	Remedy
<i>ErP0</i> ... <i>ErP19</i> <b>Trip</b>	-	Communication interruption between keypad and standard device	Various	Contact Lenze
<i>FRnI</i> <b>Trip</b>	95	Fan failure (only 8200 motec 3 ... 7.5 kW)	Fan is defective	Replace fan
<i>FRnI</i>	-	TRIP or warning configurable in C0608	Fan is not connected	Connect fan Check wiring
<i>HD5</i> <b>Trip</b>	105	Internal fault		Contact Lenze
<i>IdI</i> <b>Trip</b>	140	Faulty parameter identification	Motor is not connected	Connect motor
<i>LPI</i> <b>Trip</b>	32	Error in motor phase (Display when C0597 = 1)	<ul style="list-style-type: none"> <li>● Failure of one/several motor phase(s)</li> <li>● Motor current too low</li> </ul>	<ul style="list-style-type: none"> <li>● Check motor supply cables</li> <li>● Check <math>V_{min}</math> boost,</li> <li>● Connect motor with a corresponding power or adapt motor with C0599</li> </ul>
<i>LPI</i>	182	Error in motor phase (Display when C0597 = 2)		
<i>LU</i> <b>IMP</b>	-	DC bus undervoltage	Mains voltage too low Voltage in DC-bus connection too low 400 V controller is connected to 240 V mains	Check mains voltage Check power supply module Connect controller to correct mains voltage
<i>DCI</i> <b>Trip</b>	11	Short circuit	Short circuit  Capacitive charging current of the motor cable too high	<ul style="list-style-type: none"> <li>● Search for cause of short circuit; check motor cable</li> <li>● Check brake resistor and cable to brake resistor</li> </ul> Use shorter/low-capacitance motor cable
<i>DEC2</i> <b>Trip</b>	12	Earth fault	Earthed motor phase  Capacitive charging current of the motor cable too high	Check motor; check motor cable  Use shorter/low-capacitance motor cable  Deactivate earth-fault detection for test purposes
<i>DEC3</i> <b>Trip</b>	13	Controller overload during acceleration or short circuit	Acceleration time set is too short (C0012) Defective motor cable Interturn fault in the motor	<ul style="list-style-type: none"> <li>● Increase acceleration time</li> <li>● Check drive dimensioning</li> </ul> Check wiring Check motor
<i>DEC4</i> <b>Trip</b>	14	Controller overload during deceleration	Deceleration time set is too short (C0013)	<ul style="list-style-type: none"> <li>● Increase deceleration time</li> <li>● Check dimensioning of the external brake resistor</li> </ul>
<i>DEC5</i> <b>Trip</b>	15	Controller overload during steady-state operation	Frequent and too long overload	Check drive dimensioning
<i>DEC6</i> <b>Trip</b>	16	Motor overload ( $I^2 \times t$ overload)	Motor is thermally overloaded by e.g. <ul style="list-style-type: none"> <li>● impermissible continuous current</li> <li>● frequent or too long acceleration processes</li> </ul>	<ul style="list-style-type: none"> <li>● Check drive dimensioning</li> <li>● Check setting of C0120</li> </ul>
<i>QH</i> <b>Trip</b>	50	Heatsink temperature > +85 °C	Ambient temperature is too high	Allow controller to cool and provide better ventilation
<i>QH</i> <b>Warn</b>	-	Heatsink temperature > +80 °C	Heatsink is very dirty Impermissibly high currents or frequent and too long acceleration processes	Clean heatsink  <ul style="list-style-type: none"> <li>● Check drive dimensioning</li> <li>● Check load, exchange tight, defective bearings if necessary</li> </ul>

### 3

## Troubleshooting and fault elimination

Fault messages on the keypad or in the parameter setting program Global Drive Control

Keypad	PC <sup>1)</sup>	Fault	Cause	Remedy
<i>OH3</i> Trip	53	PTC monitoring (TRIP) (Display when C0119 = 1 or 4)	Motor too hot due to impermissibly high currents or frequent and too long acceleration processes	Check drive dimensioning
			No PTC connected	Connect PTC or switch off monitoring
<i>OH4</i> Trip	54	Controller overtemperature	Controller too hot inside	<ul style="list-style-type: none"> <li>• Reduce controller load</li> <li>• Improve cooling</li> <li>• Check fan in the controller</li> </ul>
<i>OH51</i>	203	PTC monitoring (Display when C0119 = 2 or 5)	Motor too hot due to impermissibly high currents or frequent and too long acceleration processes	Check drive dimensioning
			No PTC connected	Connect PTC or switch off monitoring
<i>OU</i> IMP <i>QUE</i> Trip	-	DC bus overvoltage (Message or TRIP configurable in C0310)	Mains voltage too high	Check supply voltage
			Braking operation	<ul style="list-style-type: none"> <li>• Increase deceleration times</li> <li>• When operating with an external brake resistor: <ul style="list-style-type: none"> <li>– Check dimensioning, connection and supply cable of the brake resistor</li> <li>– Increase deceleration times</li> </ul> </li> </ul>
			Earth leakage on the motor side	Check motor supply cable and motor for earth fault (disconnect motor from the inverter)
<i>Pr</i> Trip	75	Faulty parameter transfer with the keypad	All parameter sets are defective	Before enabling the controller, repeat the data transfer or load the Lenze setting
<i>Pr1</i> Trip	72	Faulty PAR1 transfer with keypad	Parameter set 1 is defective	
<i>Pr2</i> Trip	73	Faulty PAR2 transfer with keypad	Parameter set 2 is defective	
<i>Pr3</i> Trip	77	Faulty PAR3 transfer with keypad	Parameter set 3 is defective	
<i>Pr4</i> Trip	78	Faulty PAR4 transfer with keypad	Parameter set 4 is defective	
<i>Pr5</i> Trip	79	Internal fault	EEPROM is defective	
<i>PT5</i> Trip	81	Time error during parameter set transfer	Data flow from keypad or PC interrupted, e.g. because keypad was disconnected during transfer	Before enabling the controller, repeat the data transfer or load the Lenze setting.
<i>r5T</i> Trip	76	Error during auto TRIP reset	More than 8 error messages within 10 minutes	Depends on the error message
<i>Sd5</i> Trip	85	Open circuit - analog input 1	Current at analog input < 4 mA at setpoint range 4 ... 20 mA	Close circuit at analog input
<i>Sd7</i> Trip	87	Open circuit - analog input 2		

<sup>1)</sup> LECOM error number, display in Global Drive Control (GDC) parameter setting program

Lenze Drive Systems GmbH  
Hans-Lenze-Straße 1  
D-31855 Aerzen  
Germany



+49 (0) 51 54 82-0



Service 00 80 00 24 4 68 77 (24 h helpline)



Service +49 (0) 51 54 82-1112

E-Mail [Lenze@Lenze.de](mailto:Lenze@Lenze.de)

Internet [www.Lenze.com](http://www.Lenze.com)



EDK82EV903 1.0 07/2007  
© 2007  
TD23