

EDK82EV303
13216484

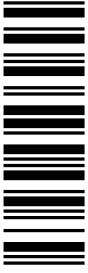

Information for the operator of the machine

8200 vector *15 ... 30 kW*

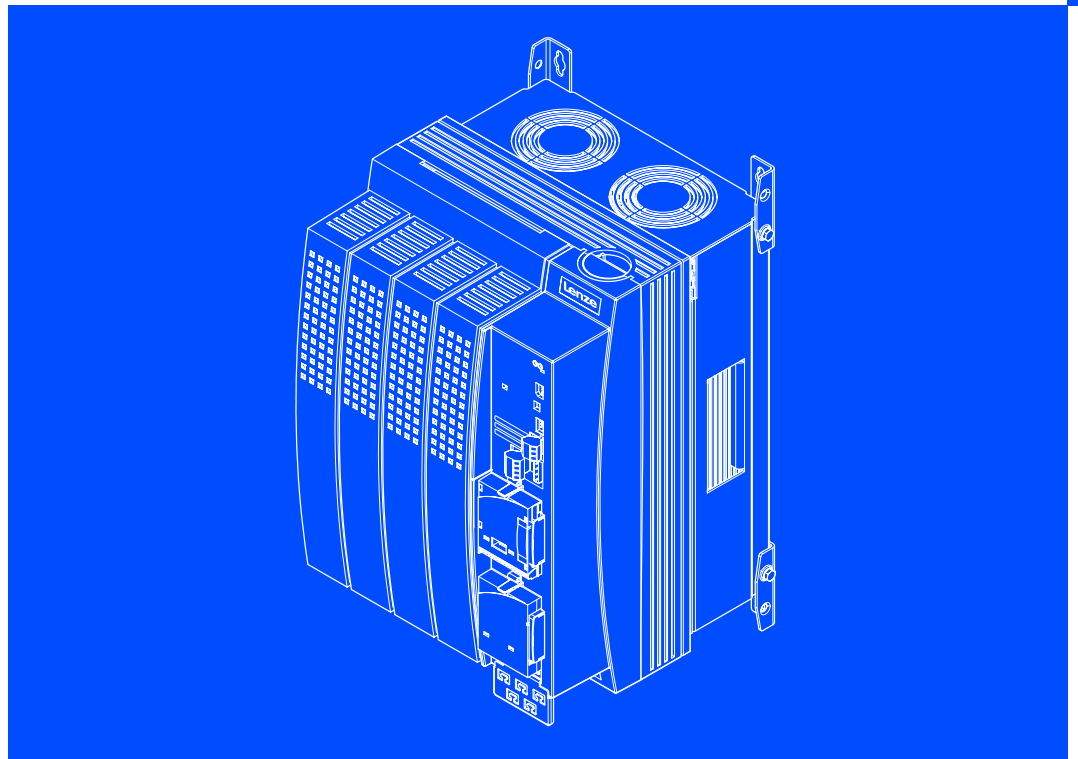

E82xV153Kxxxxx ... E82xV303Kxxxxx

Frequency inverter

Lenze

This documentation is valid for ...

... 8200 vector frequency inverters as of nameplate data:

| | ① | ② | ③ | Nameplate | | | | | | | |
|-------------------------|--|---|---|-----------|---|---|---|-----|----|----|--|
| | E82 | x | V | xxx | K | 4 | B | xxx | 3x | 3x | |
| Product series | 8200 vector | | | | | | | | | | |
| Type | E = Panel-mounted unit C = Built-in unit in "cold plate" technique D = Built-in unit in "push-through" technique | | | | | | | | | | |
| Design | V = Vector-controlled frequency inverter | | | | | | | | | | |
| Rated power [W] | 153 = $15 \times 10^3 \text{ W} = 15 \text{ kW}$ 223 = $22 \times 10^3 \text{ W} = 22 \text{ kW}$ 303 = $30 \times 10^3 \text{ W} = 30 \text{ kW}$ | | | | | | | | | | |
| Voltage class | 4 = 400 V / 500 V | | | | | | | | | | |
| Version | | | | | | | | | | | |
| Variant | 0xx = EMC filter integrated 1xx = For IT systems 2xx = Without EMC filter x0x = Without "safe standstill" function x4x = With "safe standstill" function xx0 = Not coated xx1 = Coated | | | | | | | | | | |
| Hardware version | | | | | | | | | | | |
| Software version | | | | | | | | | | | |

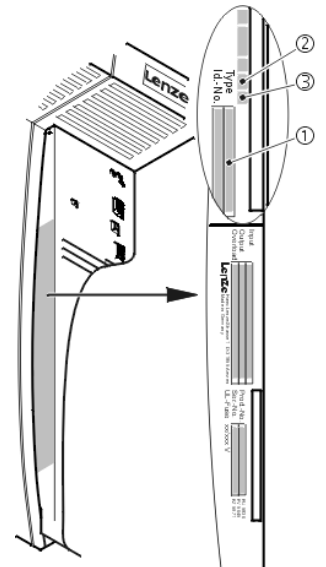

9300vec112



Note!

This documentation contains all the information required by the machine operator to run the drive controllers of the 8200 vector series installed in your machine/system.

You may make further use of the information contained in this documentation without asking Lenze for permission if you do not change the contents.



Tip!

Current documentation and software updates concerning Lenze products can be found on the Internet in the "Services & Downloads" area under

<http://www.Lenze.com>

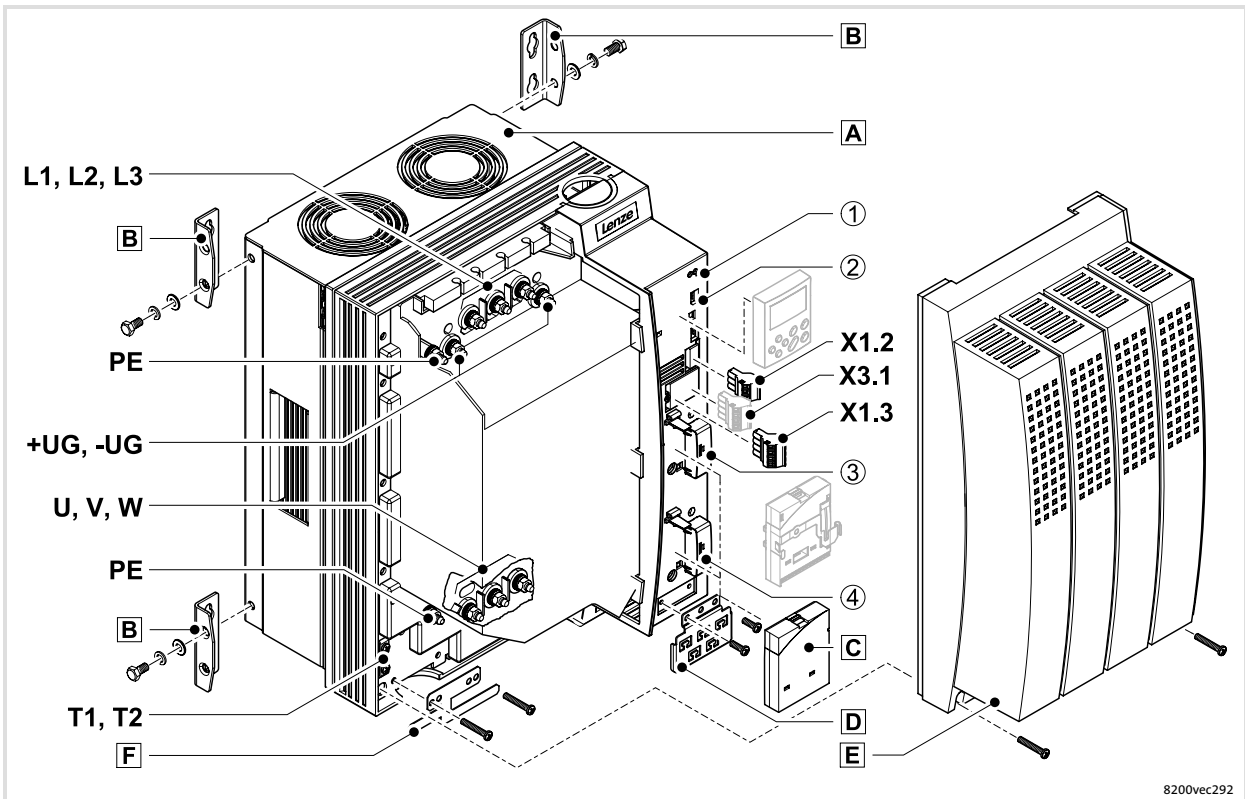

Key for overview

| Position | Description |
|-----------------------------------|---|
| A | 8200 vector frequency inverter |
| B | Fixing bracket for standard mounting |
| C | Blind covers (2 pcs) for the FIF I and FIF II interfaces |
| D | EMC shield sheet with fixing screws for shielded control cables |
| E | Cover with fixing screws |
| F | EMC shield sheet for the motor cable and for the incoming motor temperature monitoring cable |
| T1, T2 | Connection for PTC or thermal contact (NC contact) of the motor |
| U, V, W, PE | Motor connection |
| L1, L2, L3, PE | Mains connection |
| +U _G , -U _G | DC supply |
| X1.2 | Terminal strip for connection of relay output K1 |
| X1.3 | Terminal strip for connection of relay output K2 |
| X3.1 | Terminal strip for connection of relay output K _{SR} for "safe standstill" (for Bx4x variant only) |

Interfaces and displays

| Position | Description | Function |
|----------|--|---|
| ① | 2 light-emitting diodes (red, green) | Status display |
| ② | AIF interface (automation interface) | Slot for communication module e. g. E82ZBC keypad |
| ③ | FIF I interface (function interface) | With cover for operation without function module or slot for function module |
| ④ | FIF II interface (function interface) | With cover for operation without function module or slot for function module |

| | | |
|----------|--|-----------|
| 1 | Safety instructions | 7 |
| 1.1 | General safety and application notes for Lenze controllers | 7 |
| 1.2 | Residual hazards | 9 |
| 1.3 | Definition of notes used | 11 |
| 2 | Parameter setting | 12 |
| 2.1 | Parameter setting with E82ZBC keypad | 12 |
| 2.1.1 | Installation and commissioning | 12 |
| 2.1.2 | Display elements and function keys | 13 |
| 2.1.3 | Changing and saving parameters | 15 |
| 2.1.4 | Menu structure | 16 |
| 3 | Troubleshooting and fault elimination | 18 |
| 3.1 | Malfunction of the drive | 18 |
| 3.2 | Troubleshooting | 19 |
| 3.3 | Fault messages on the keypad or in the parameter setting program Global Drive Control | 20 |

1 Safety instructions

1.1 General safety and application notes for Lenze controllers

(in accordance with Low-Voltage Directive 2006/95/EC)

For your personal safety

Lenze controllers (frequency inverters, servo inverters, DC speed controllers) and the accessory components can include live and rotating parts - depending on their type of protection - during operation. Surfaces can be hot.

Non-authorized removal of the required cover, inappropriate use, incorrect installation or operation, create the risk of severe injury to persons or damage to material assets.

More information can be obtained from the documentation.

Within the controller there are high energies. Therefore always wear personal protective equipment when working on the live controller (body protection, headgear, eye protection, ear protection, hand guard).

All operations concerning transport, installation, and commissioning as well as maintenance must be carried out by qualified, skilled personnel (IEC 364 and CENELEC HD 384 or DIN VDE 0100 and IEC report 664 or DIN VDE 0110 and national regulations for the prevention of accidents must be observed).

According to this basic safety information, qualified, skilled personnel are persons who are familiar with the assembly, installation, commissioning, and operation of the product and who have the qualifications necessary for their occupation.

Application as directed

Drive controllers are components which are designed for the installation into electrical systems or machinery. They are not to be used as domestic appliances, but as components only for industrial or professional purposes according to EN 61000-3-2.

When installing the controllers into machines, commissioning (i.e. starting of operation as directed) is prohibited until it is proven that the machine complies with the regulations of the EC Directive 98/37/EC (Machinery Directive); EN 60204 must be observed.

Commissioning (i.e. starting of operation as directed) is only allowed when there is compliance with the EMC Directive (89/336/EEC).

The controllers meet the requirements of the Low-Voltage Directive 73/23/EEC. The harmonised standard EN 61800-5-1 applies to the controllers.

The technical data and information on connection conditions must be obtained from the nameplate and the documentation. They must be observed in any case.

Warning: Drive controllers are products that can be used in drive systems of category 2 according to EN 61800-3. These products can cause radio interferences in residential areas. In this case, special measures are required.

Transport, storage

Please observe the notes on transport, storage and appropriate handling.

Observe the climatic conditions according to the technical data.

Installation

The controllers must be installed and cooled according to the instructions given in the corresponding documentation.

Ensure proper handling and avoid mechanical stress. Do not bend any components and do not change any insulation distances during transport or handling. Do not touch any electronic components and contacts.

Controllers contain electrostatically sensitive components, which can easily be damaged by inappropriate handling. Do not damage or destroy any electrical components since this might endanger your health!

Electrical connection

When working on live controllers, the valid national regulations for the prevention of accidents (e.g. VBG 4) must be observed.

The electrical installation must be carried out according to the appropriate regulations (e.g. cable cross-sections, fuses, PE connection). Additional information can be obtained from the documentation.

The documentation contains notes for the EMC-compliant installation (shielding, earthing, arrangement of filters, and cable routing). Also observe these notes for CE-labelled controllers. The manufacturer of the system or machine is responsible for the compliance with the limit values required in connection with EMC legislation. In order to comply with the limit values for radio interference applicable at the site of installation, you have to fit the controllers into housings (e. g. control cabinets). The housings have to provide for an EMC-compatible assembly. In particular, observe that for instance doors of control cabinets preferably are metalically connected to the housing in a circumferential manner. Reduce apertures or cutouts through the housing to a minimum.

Lenze controllers can cause a DC current within the PE conductor. If a residual current device (RCD) is used for protection in the cases of direct or indirect contact, only a residual current device (RCB) of the type B may be used on the supply side of the controller. Otherwise a different protective measure has to be used, e. g. separation from the environment by double or reinforced insulation, or disconnection from the supply system by using a transformer.

Operation

If necessary, systems including controllers must be equipped with additional monitoring and protection devices according to the valid safety regulations (e.g. law on technical equipment, regulations for the prevention of accidents). The controller can be adapted to your application. Please observe the corresponding information given in the documentation.

After a controller has been disconnected from the voltage supply, all live components and power connections must not be touched immediately because capacitors can still be charged. Please observe the corresponding stickers on the controller.

All protection covers and doors must be shut during operation.

Note for UL approved systems with integrated controllers: UL warnings are notes that only apply to UL systems. The documentation contains special information about UL.

Safety functions

Some variants of the controllers support safety functions (e. g. "safe torque off", formerly "safe standstill") according to the requirements of Appendix I no. 1.2.7 of the EC Directive "Machinery" 98/37/EC, EN 954-1 category 3 and EN 1037. The notes on the safety functions in the documentation of the variants must be strictly observed.

Maintenance and servicing

The controllers do not require any maintenance, if the prescribed conditions of operation are observed.

If the ambient air is polluted, the cooling surfaces of the controller may become dirty or the air vents of the controller may be obstructed. Therefore, clean the cooling surfaces and air vents periodically under these operating conditions. Do not use sharp or pointed tools for this purpose!

Disposal

Recycle metal and plastic materials. Ensure professional disposal of assembled PCBs.

The product-specific safety and application notes given in these instructions must be observed!

1.2

Residual hazards

Protection of persons

- ▶ Before working on the drive controller, check whether all power terminals, the relay output, and the pins of the FIF interfaces are deenergised, because
 - the power terminals U, V, W, +U_G, -U_G still carry dangerous voltage for at least 3 minutes after power-off.
 - the power terminals L1, L2, L3, U, V, W, +U_G, -U_G carry dangerous voltage when the motor is stopped.
 - the relay outputs K11, K12, K14 and K21, K22, K24 can carry dangerous voltage if the drive controller is disconnected from the mains.
- ▶ If you use the “selection of direction of rotation” via function which is not fail-safe against open circuit via the digital signal DCTRL1-CW/CCW (C0007 = 0 ... 13, C0410/3 ≠ 255):
 - In case of open circuit or failure of the control voltage, the drive may change the direction of rotation.
- ▶ If you use the “flying restart circuit” function (C0142 = 2, 3) for machines with a low moment of inertia and low friction:
 - After controller enable in standstill, the motor may start for a short period of time, or may temporarily change the direction of rotation.
- ▶ The operating temperature of the heatsink on the drive controller is > 80 °C:
 - Skin contact with the heatsink causes burns.
- ▶ Drive controllers with the “safe standstill” function:
 - In case of short circuit of two power transistors, a residual movement of up to 180°/number of pole pairs may result on the motor.
 - With regard to a 4-pole motor, for instance, the residual movement can be maximal 180°/2 = 90°. When effecting the hazard analysis, the user has to take this residual movement into account (e. g. safe standstill for main spindle drives).

Device protection

- ▶ All pluggable terminals can only be plugged in or unplugged when the controller is disconnected from the power supply!
- ▶ Frequent mains switching (e.g. inching mode via mains contactor) can overload and destroy the input current limitation of the controller:
 - Therefore at least 3 minutes must pass between two switch-on operations.

Motor protection

- ▶ Certain drive controller settings can overheat the connected motor:
 - E. g. long-time operation of the DC injection brake.
 - Long-time operation of self-ventilated motors at low speeds.

Protection of the machine/system

- ▶ Drives can reach dangerous overspeeds (e. g. setting of high output frequencies in connection with motors and machines not suitable for this purpose):
 - The drive controllers do not provide protection against such operating conditions. For this purpose, use additional components.

**Warnings!**

- ▶ The device has no overspeed protection.
- ▶ Must be provided with external or remote overload protection.
- ▶ Suitable for use on a circuit capable of delivering not more than 5000 rms symmetrical amperes, 240 V maximum (240 V devices) or 500 V maximum (400/500 V devices) resp.
- ▶ Use 60/75 °C or 75 °C copper wire only.
- ▶ Shall be installed in a pollution degree 2 macro-environment.

1.3 Definition of notes used

The following pictographs and signal words are used in this documentation to indicate dangers and important information:

Safety instructions

Structure of safety instructions:





Danger!



(characterises the type and severity of danger)

Note

(describes the danger and gives information about how to prevent dangerous situations)

| Pictograph and signal word | Meaning |
|---|--|
|  Danger! | Danger of personal injury through dangerous electrical voltage. Reference to an imminent danger that may result in death or serious personal injury if the corresponding measures are not taken. |
|  Danger! | Danger of personal injury through a general source of danger. Reference to an imminent danger that may result in death or serious personal injury if the corresponding measures are not taken. |
|  Stop! | Danger of property damage. Reference to a possible danger that may result in property damage if the corresponding measures are not taken. |

Application notes

| Pictograph and signal word | Meaning |
|--|--|
|  Note! | Important note to ensure troublefree operation |
|  Tip! | Useful tip for simple handling |
|  | Reference to another documentation |

2 Parameter setting

Parameter setting with E82ZBC keypad Installation and commissioning

2 Parameter setting

2.1 Parameter setting with E82ZBC keypad

Description

The keypad is available as an accessory. A full description of the keypad can be obtained from the Instructions included in the keypad delivery.

Plugging in the keypad

It is possible to plug the keypad into the AIF interface or remove it during operation.

As soon as the keypad is supplied with voltage, it carries out a self-test. The keypad is ready for operation if it is in display mode.

2.1.1 Installation and commissioning

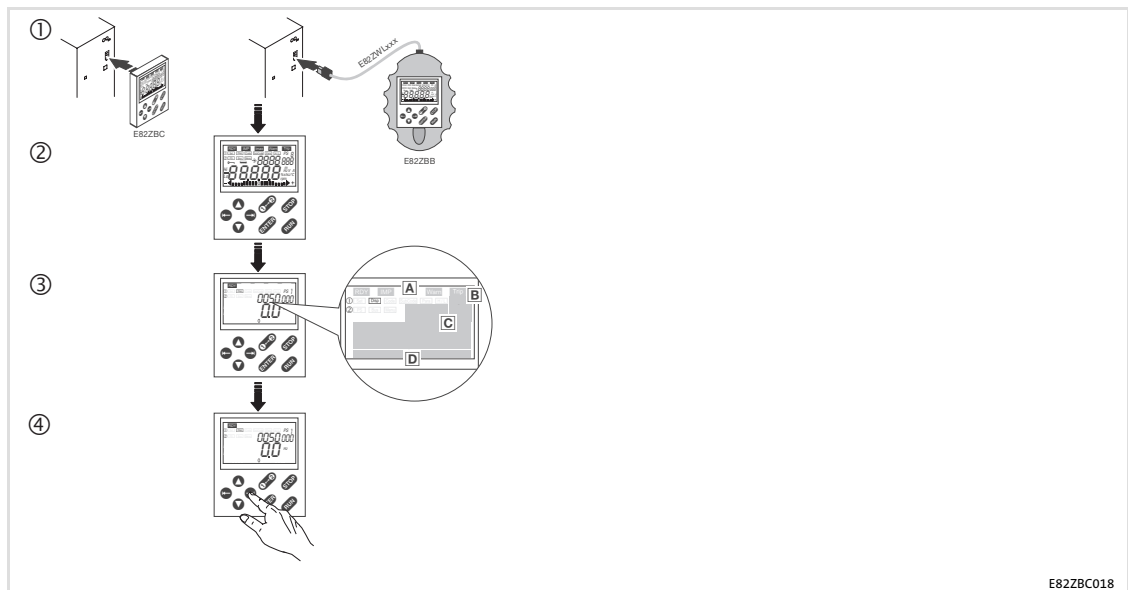

- ① Connect keypad to the AIF interface on the front of the standard device.
It is possible to connect the keypad and remove it during operation.
- ② As soon as the keypad is supplied with voltage, it carries out a short self-test.
- ③ The keypad is ready for operation, if it displays the "Disp" mode:
 - A Current state of the standard device
 - B Parameter set activated via terminal
 - C Memory location 1 of the user menu (C0517):
Code number, subcode number, and current value
 - D Current value in % of the status display defined in C0004
- ④ Press **Disp** to leave the "Disp" mode

2.1.2 Display elements and function keys

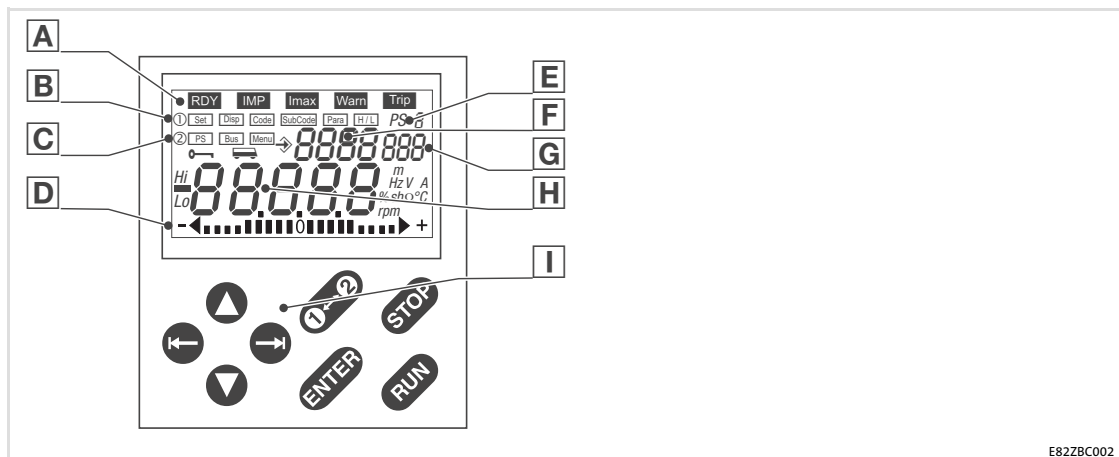

E82ZBC002

Displays







| Display | Meaning | Explanation |
|----------------|---|--|
| A | Status displays | |
| RDY | Ready for operation | |
| IMP | Pulse inhibit active | Power outputs are inhibited |
| Imax | Set current limit exceeded in motor or generator mode | C0022 (in motor mode) or C0023 (in generator mode) |
| Warn | Warning active | |
| Trip | Fault active | |
| B | Function bar 1 | |
| Set | Setpoint selection via | Not possible if password protection is active (display = "LDC") |
| Disp | Display function: • Display user menu, memory location 1 (C0517/1) • Display active parameter set | Active after every mains connection |
| Code | Select codes | Four-digit display of the active code F |
| SubCode | Select subcodes | Three-digit display of the active subcode G |
| Para | Change parameter value of a code/subcode | Five-digit display of the actual value H |
| HTL | Display values which have more than 5 digits | |
| | H: higher-order digits | Display of "Hi" |
| | L: lower-order digits | Display of "Lo" |
| C | Function bar 2 | |
| PS | Select parameter set 1 ... 4 for changing | <ul style="list-style-type: none"> • Display of e.g. PS 2 (E) • The parameter sets can only be activated via digital signals (configuration with C0410) |
| Bus | Select node of the system bus (CAN) | The selected node can be parameterised from the current drive = Function is active |
| Menu | Select menu The user menu is active after every mains switching | <i>user</i> List of the codes in the user menu (C0517) <i>ALL</i> List of all codes <i>Func</i> Only specific codes for bus function modules, e.g. INTERBUS, PROFIBUS-DP, LECOM-B, ... |

Parameter setting

Parameter setting with E82ZBC keypad
Display elements and function keys

| Display | Meaning | Explanation |
|----------|---|--|
| D | Bar graph display | |
| | Value set in C0004 in % (Lenze setting: Device utilisation C0056) | Display range: - 180 % ... + 180 % (1 mark = 20 %) |
| E | Parameter set display | |
| | In the [Disp] mode: Display of the parameter set activated via digital signal | |
| | Otherwise: Display of the parameter set active for changing | Select the individual parameter sets in the [PS] mode in the function bar 2 |
| F | Code number display | |
| G | Subcode number display | |
| H | Display of parameter value or fault message | |

Function keys

| Pos. | Key | Function | Explanation |
|----------|---|--|--|
| I | Function keys | | |
| |  | Enable controller | For operation with a function module, the X3/28 terminal must be set to HIGH level. |
| |  | Inhibit controller (CINH) or quick stop (QSP) | Configuration in C0469; inactive if the standard device is running in manual mode (C0410/17) |
| |  | Change between function bar 1 ↔ function bar 2 | |
| |  | To the right/left in the active function bar | The active function is framed. |
| |  | Increase/decrease value Quick change: Keep the key pressed | Only blinking values can be changed. |
| |  | Store parameters if  is blinking Confirmation by <i>STO-r-E</i> in the display | |

2.1.3 Changing and saving parameters



Note!

- ▶ The *USER* menu is active after mains switching. Change to the *ALL* menu to address all codes.
- ▶ With the keypad you can only change parameter values in the parameter sets.
- ▶ A parameter set can only be activated for operation by means of digital signals (configuration via C0410)!
- ▶ In the Disp function, the keypad shows the parameter set which is currently active during operation.

| Step | Key sequence | Result | Action |
|------|---------------------------------------|--|---|
| 1. | Connect keypad | Disp XX.XX Hz | The Disp function is active. The first code in the user menu is displayed (C0517/1, Lenze setting: C0050 = output frequency). |
| 2. | If required, change to the "ALL" menu | | Change to function bar 2 |
| 3. | | | |
| 4. | | <i>ALL</i> | Select "ALL" menu (list of all codes) |
| 5. | | | Confirm selection and change to function bar 1 |
| 6. | Select parameter set for change | | Change to function bar 2 |
| 7. | | PS | |
| 8. | | <i>1 ... 4</i> | Select parameter set to be changed |
| 9. | | | Confirm selection and change to function bar 1 |
| 10. | Inhibit controller | STOP | RDY IMP Only necessary if you change C0002, C0148, C0174, and/or C0469 |
| 11. | Set parameters | | Code |
| 12. | | XXXX | Select code |
| 13. | | SubCode 00i | For codes without subcodes: automatic skip to Para |
| 14. | | XXX | Select subcode |
| 15. | | Para | |
| 16. | | XXXXX | Set parameter |
| 17. | | ENTER | Confirm entry if is blinking |
| | | | Confirm entry if is not blinking; ENTER is inactive |
| 18. | | | Restart "loop" at 11. or 6. to set further parameters |

2.1.4 Menu structure

For easy operation, the codes are grouped into two menus:

- ▶ The *uSEr* menu
 - is active after every mains switching or after connection of the keypad during operation.
 - contains all codes for a standard application with linear V/f characteristic control (Lenze setting).
 - can be modified as required under C0517.
- ▶ The *ALL* menu
 - contains all codes.
 - shows a list of all codes in numerically ascending order.

The *uSEr* menu - the 10 most important drive parameters at a glance

After every mains switching, or after connection of the keypad during operation, the 10 codes that have been defined in code C0517 are immediately available.

In the Lenze setting, the *uSEr* menu contains all codes required for starting up a standard application with linear V/f characteristic control:

| Code | Designation | Lenze setting | | | | |
|-------|---------------------------------------|---|--|--------------------|------------------------------|--------|
| C0050 | Output frequency | Display: output frequency without slip compensation | | | | |
| C0034 | Setpoint selection range | 0 | Standard I/O X3/8: 0 ... 5 V / 0 ... 10 V / 0 ... 20 mA | | | |
| | | | Application I/O X3/1U: 0 ... 5 V / 0 ... 10 V X3/2U: 0 ... 5 V / 0 ... 10 V | | | |
| C0007 | Fixed configuration of digital inputs | 0 | E4 | E3 | E2 | |
| | | | CW/CCW | DCB | JOG2/3 | JOG1/3 |
| | | | CW/CCW rotation | DC injection brake | Selection of fixed setpoints | |
| C0010 | Minimum output frequency | 0.00 Hz | | | | |
| C0011 | Maximum output frequency | 50.00 Hz | | | | |
| C0012 | Acceleration time of main setpoint | 5.00 s | | | | |
| C0013 | Deceleration time main of setpoint | 5.00 s | | | | |
| C0015 | V/f rated frequency | 50.00 Hz | | | | |
| C0016 | V _{min} boost | Device-dependent | | | | |
| C0002 | Parameter set management | Re-establish delivery status; transfer parameter sets with the keypad; save, load, or copy own basic settings | | | | |



Note!

Via C0002 "parameter set transfer/re-establishing of delivery status", you can transfer configurations from one drive controller to another by means of the keypad, or re-establish the delivery status by loading the Lenze setting (e. g. if you've lost track during parameterising).

Change between the menus *USER* and *ALL*

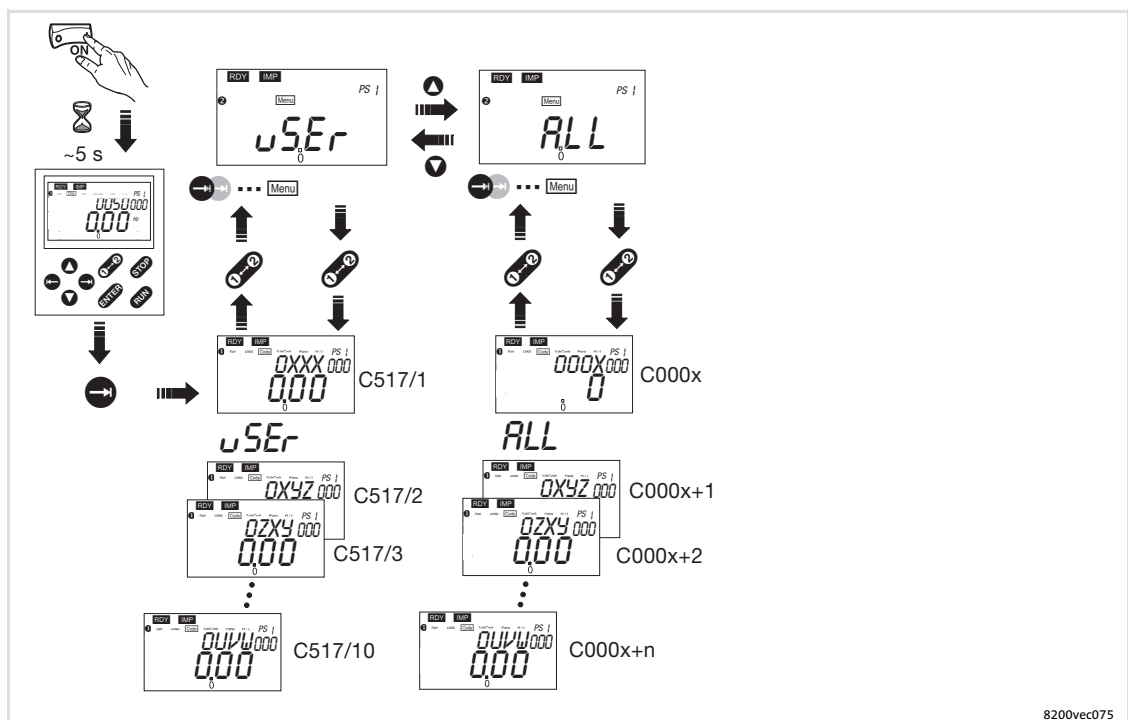

8200vec075

3 Troubleshooting and fault elimination

Malfunction of the drive

3 Troubleshooting and fault elimination

3.1 Malfunction of the drive

| Malfunction | Cause | Remedy |
|--|--|---|
| Motor does not rotate | DC-bus voltage too low (red LED is blinking every 0.4 s; keypad displays: <i>LL</i>) | Check mains voltage |
| | Controller inhibited (green LED is blinking, keypad displays: <i>IMP</i>) | Deactivate controller inhibit, controller inhibit can be set via several sources |
| | Automatic start inhibited (C0142 = 0 or 2) | LOW-HIGH edge at X3/28 If necessary, correct starting condition (C0142) |
| | DC-injection braking (DCB) active | Deactivate DC injection brake |
| | Mechanical motor brake is not released | Manual or electrical release of mechanical motor brake |
| | Quick stop (QSP) active (keypad displays: <i>IMP</i>) | Deactivate quick stop |
| | Setpoint = 0 | Select setpoint |
| | JOG setpoint activated and JOG frequency = 0 | Select JOG setpoint (C0037 ... C0039) |
| | Active fault | Eliminate fault |
| | Incorrect parameter set active | Change to correct parameter set via terminal |
| | Operating mode C0014 = -4-, -5- set, but no motor parameter identification | Identify motor parameters (C0148) |
| | Assignment of several functions excluding each other to one signal source in C0410 | Correct configuration in C0410 |
| | Use of internal voltage source X3/20 for the function modules Standard I/O, INTERBUS, PROFIBUS-DP, or LECOM-B (RS485): No jumper between X3/7 and X3/39 | Jumper terminals |
| Motor does not rotate smoothly | Motor cable defective | Check motor cable |
| | Maximum current set too low (C0022, C0023) | Adjust settings to the application |
| | Motor is under- or overexcited | Check parameter setting (C0015, C0016, C0014) |
| | C0084, C0087, C0088, C0089, C0090, C0091 and/or C0092 not adjusted to the motor data | Adjust codes manually or identify motor parameters (C0148); optimise vector control |
| Current consumption of motor too high | Setting of C0016 too high | Correct setting |
| | Setting of C0015 too low | Correct setting |
| | C0084, C0087, C0088, C0089, C0090, C0091 and/or C0092 not adjusted to the motor data | Adjust codes manually or identify motor parameters (C0148); optimise vector control |
| Motor rotates, setpoints are "0" | With the <input type="checkbox"/> <i>Set</i> function of the keypad a setpoint has been selected | Set setpoint to "0" with C0140 = 0 |
| Motor parameter identification stops with error LP1 | Motor is too small in relation to the rated power of the drive | |
| | DC injection brake (DCB) active via terminal | |
| Unacceptable drive response with vector control | Various | Optimise vector control |
| Torque dip in the field weakening range | Various | Contact Lenze |
| Stalling of the motor when operating in the field weakening range | | |

3.2 Troubleshooting

| LED red ① | LED green ② | Operating status |
|------------------|------------------|---|
| Off | On | Drive controller enabled |
| On | On | Mains switched on and automatic start inhibited |
| Off | Blinking slowly | Drive controller inhibited |
| Off | Blinking quickly | Motor parameter identification |
| Blinking quickly | Off | Undervoltage or overvoltage |
| Blinking slowly | Off | Fault active, check in C0161 |

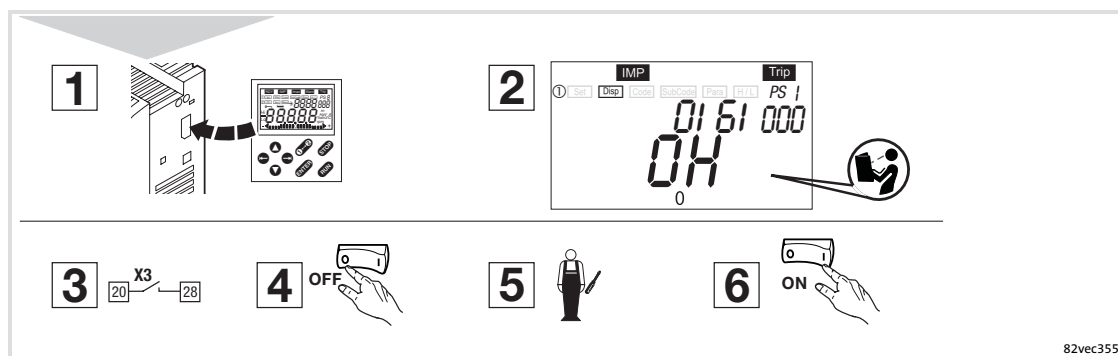
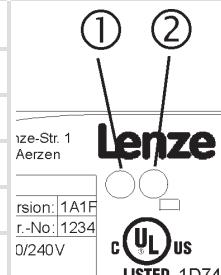

Reset the drive controller in this way if a fault occurs (TRIP reset):

1. Plug the keypad onto the AIF interface during operation.
2. Read and take down fault message on the keypad display.
3. Inhibit controller.
4. Disconnect controller from the mains.
5. Carry out a fault analysis and eliminate the faults.
6. Restart the controller.

3.3 Fault messages on the keypad or in the parameter setting program Global Drive Control

| Keypad | PC 1) | Fault | Cause | Remedy |
|-------------|-------|---|--|--|
| nDEr | 0 | No fault | - | - |
| CCr Trip | 71 | System failure | Strong interference injections on the control cables Earth loops in the wiring | Shield control cable |
| CE0 Trip | 61 | Communication error on AIF (configurable in C0126) | Faulty transmission of control commands via AIF | Insert the communication module properly into the diagnosis terminal |
| CE1 Trip | 62 | Communication error on CAN-IN1 with sync control | CAN-IN1 object receives faulty data or communication is interrupted | <ul style="list-style-type: none"> • Check plug connection of bus module ↔ FIF • Check sender • Increase monitoring time in C0357/1, if necessary |
| CE2 Trip | 63 | Communication error on CAN-IN2 | CAN-IN2 object receives faulty data or communication is interrupted | <ul style="list-style-type: none"> • Check plug connection of bus module ↔ FIF • Check sender • Increase monitoring time in C0357/2, if necessary |
| CE3 Trip | 64 | Communication error on CAN-IN1 with event or time control | CAN-IN1 object receives faulty data or communication is interrupted | <ul style="list-style-type: none"> • Check plug connection of bus module ↔ FIF • Check sender • Increase monitoring time in C0357/3, if necessary |
| CE4 Trip | 65 | BUS-OFF (many communication errors occurred) | Controller has received too many faulty telegrams via the system bus and has been disconnected from the bus | <ul style="list-style-type: none"> • Check whether bus termination is available • Check shield connection of the cables • Check PE connection • Check bus load, reduce the baud rate, if necessary |
| CE5 Trip | 66 | CAN time-out (configurable in C0126) | In case of remote parameterisation via the system bus (C0370): Slave does not respond. Communication monitoring time has been exceeded When operating with Application I/O: Parameter set change-over has been parameterised incorrectly When operating with module on FIF: Internal error | <ul style="list-style-type: none"> • Check wiring of the system bus • Check system bus configuration In all parameter sets, the "change parameter set" signal (C0410/13, C0410/14) must be connected with the same source Contact Lenze |
| CE6 Trip | 67 | System bus (CAN) function module on FIF has the "Warning" or "BUS-OFF" status (configurable in C0126) | CAN controller signals "Warning" or "BUS-OFF" status | <ul style="list-style-type: none"> • Check whether bus termination is available • Check shield connection of the cables • Check PE connection • Check bus load, reduce the baud rate, if necessary |
| CE7 Trip | 68 | Communication error in case of remote parameterisation via the system bus (C0370) (configurable in C0126) | Node does not respond or is not available When operating with Application I/O: Parameter set change-over has been parameterised incorrectly | <ul style="list-style-type: none"> • Check whether bus termination is available • Check shield connection of the cables • Check PE connection • Check bus load, reduce the baud rate, if necessary In all parameter sets, the "change parameter set" signal (C0410/13, C0410/14) must be connected with the same source |
| EEr Trip | 91 | External fault (TRIP-SET) | A digital signal assigned to the TRIP-SET function is activated | Check external encoder |

| Keypad | PC 1) | Fault | Cause | Remedy |
|---|-------|---|---|--|
| <i>ErPD</i> ... <i>ErPI9</i> Trip | - | Communication interruption between keypad and standard device | Various | Contact Lenze |
| <i>FRnI</i> Trip | 95 | Fan failure (only 8200 motec 3 ... 7.5 kW) | Fan is defective | Replace fan |
| <i>FRnI</i> | - | TRIP or warning configurable in C0608 | Fan is not connected | Connect fan Check wiring |
| <i>HD5</i> Trip | 105 | Internal fault | | Contact Lenze |
| <i>IdI</i> Trip | 140 | Faulty parameter identification | Motor is not connected | Connect motor |
| <i>LPI</i> Trip | 32 | Error in motor phase (Display when C0597 = 1) | <ul style="list-style-type: none"> ● Failure of one/several motor phase(s) ● Motor current too low | <ul style="list-style-type: none"> ● Check motor supply cables ● Check V_{min} boost, ● Connect motor with a corresponding power or adapt motor with C0599 |
| <i>LPI</i> | 182 | Error in motor phase (Display when C0597 = 2) | | |
| <i>LU</i> IMP | - | DC bus undervoltage | Mains voltage too low Voltage in DC-bus connection too low 400 V controller is connected to 240 V mains | Check mains voltage Check power supply module Connect controller to correct mains voltage |
| <i>DCI</i> Trip | 11 | Short circuit | Short circuit Capacitive charging current of the motor cable too high | <ul style="list-style-type: none"> ● Search for cause of short circuit; check motor cable ● Check brake resistor and cable to brake resistor Use shorter/low-capacitance motor cable |
| <i>DC2</i> Trip | 12 | Earth fault | Earthed motor phase Capacitive charging current of the motor cable too high | Check motor; check motor cable Use shorter/low-capacitance motor cable Deactivate earth-fault detection for test purposes |
| <i>DC3</i> Trip | 13 | Controller overload during acceleration or short circuit | Acceleration time set is too short (C0012) Defective motor cable Interturn fault in the motor | <ul style="list-style-type: none"> ● Increase acceleration time ● Check drive dimensioning Check wiring Check motor |
| <i>DC4</i> Trip | 14 | Controller overload during deceleration | Deceleration time set is too short (C0013) | <ul style="list-style-type: none"> ● Increase deceleration time ● Check dimensioning of the external brake resistor |
| <i>DC5</i> Trip | 15 | Controller overload during steady-state operation | Frequent and too long overload | Check drive dimensioning |
| <i>DC6</i> Trip | 16 | Motor overload ($I^2 \times t$ overload) | Motor is thermally overloaded by e.g. <ul style="list-style-type: none"> ● impermissible continuous current ● frequent or too long acceleration processes | <ul style="list-style-type: none"> ● Check drive dimensioning ● Check setting of C0120 |
| <i>QH</i> Trip | 50 | Heatsink temperature > +85 °C | Ambient temperature is too high | Allow controller to cool and provide better ventilation |
| <i>QH</i> Warn | - | Heatsink temperature > +80 °C | Heatsink is very dirty Impermissibly high currents or frequent and too long acceleration processes | Clean heatsink <ul style="list-style-type: none"> ● Check drive dimensioning ● Check load, exchange tight, defective bearings if necessary |

3

Troubleshooting and fault elimination

Fault messages on the keypad or in the parameter setting program Global Drive Control

| Keypad | PC ¹⁾ | Fault | Cause | Remedy |
|--|------------------|---|--|--|
| <i>OH3</i> Trip | 53 | PTC monitoring (TRIP) (Display when C0119 = 1 or 4) | Motor too hot due to impermissibly high currents or frequent and too long acceleration processes | Check drive dimensioning |
| | | | No PTC connected | Connect PTC or switch off monitoring |
| <i>OH4</i> Trip | 54 | Controller overtemperature | Controller too hot inside | <ul style="list-style-type: none"> • Reduce controller load • Improve cooling • Check fan in the controller |
| <i>OH51</i> | 203 | PTC monitoring (Display when C0119 = 2 or 5) | Motor too hot due to impermissibly high currents or frequent and too long acceleration processes | Check drive dimensioning |
| | | | No PTC connected | Connect PTC or switch off monitoring |
| <i>OU</i> IMP <i>QUE</i> Trip | - | DC bus overvoltage (Message or TRIP configurable in C0310) | Mains voltage too high | Check supply voltage |
| | | | Braking operation | <ul style="list-style-type: none"> • Increase deceleration times • When operating with an external brake resistor: <ul style="list-style-type: none"> – Check dimensioning, connection and supply cable of the brake resistor – Increase deceleration times |
| | | | Earth leakage on the motor side | Check motor supply cable and motor for earth fault (disconnect motor from the inverter) |
| <i>Pr</i> Trip | 75 | Faulty parameter transfer with the keypad | All parameter sets are defective | Before enabling the controller, repeat the data transfer or load the Lenze setting |
| <i>Pr1</i> Trip | 72 | Faulty PAR1 transfer with keypad | Parameter set 1 is defective | |
| <i>Pr2</i> Trip | 73 | Faulty PAR2 transfer with keypad | Parameter set 2 is defective | |
| <i>Pr3</i> Trip | 77 | Faulty PAR3 transfer with keypad | Parameter set 3 is defective | |
| <i>Pr4</i> Trip | 78 | Faulty PAR4 transfer with keypad | Parameter set 4 is defective | |
| <i>Pr5</i> Trip | 79 | Internal fault | EEPROM is defective | |
| <i>PT5</i> Trip | 81 | Time error during parameter set transfer | Data flow from keypad or PC interrupted, e.g. because keypad was disconnected during transfer | Before enabling the controller, repeat the data transfer or load the Lenze setting. |
| <i>r5T</i> Trip | 76 | Error during auto TRIP reset | More than 8 error messages within 10 minutes | Depends on the error message |
| <i>Sd5</i> Trip | 85 | Open circuit - analog input 1 | Current at analog input < 4 mA at setpoint range 4 ... 20 mA | Close circuit at analog input |
| <i>Sd7</i> Trip | 87 | Open circuit - analog input 2 | | |

¹⁾ LECOM error number, display in Global Drive Control (GDC) parameter setting program

Lenze Drive Systems GmbH
Hans-Lenze-Straße 1
D-31855 Aerzen
Germany



+49 (0) 51 54 82-0

 Service

00 80 00 24 4 68 77 (24 h helpline)

 Service

+49 (0) 51 54 82-1112

E-Mail

Lenze@Lenze.de

Internet

www.Lenze.com

EDK82EV303
EN 1.0
© 07/2007
TD23

